

Corveta

ref. ELBRC103 AL

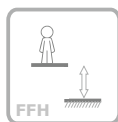

3-14 YEARS



1.80 m

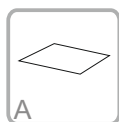

148m²

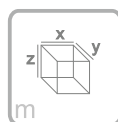

x= 13.80
y= 8.12
z= 6.15



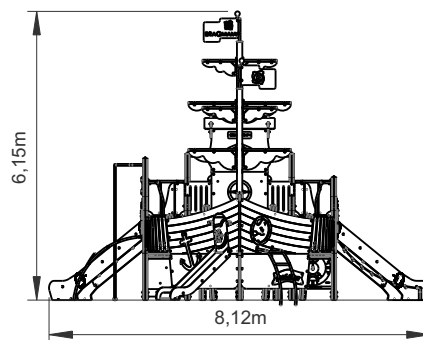
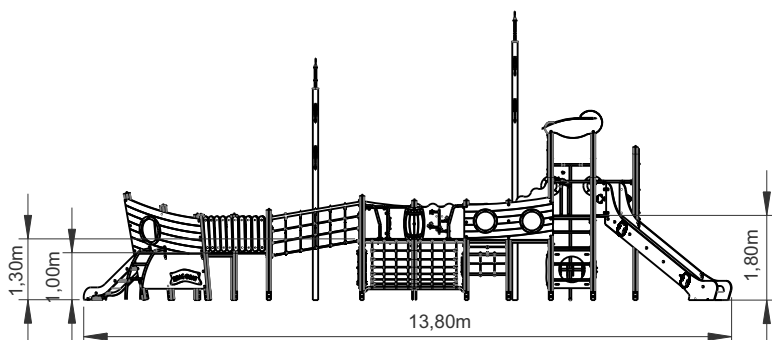

Data Sheet



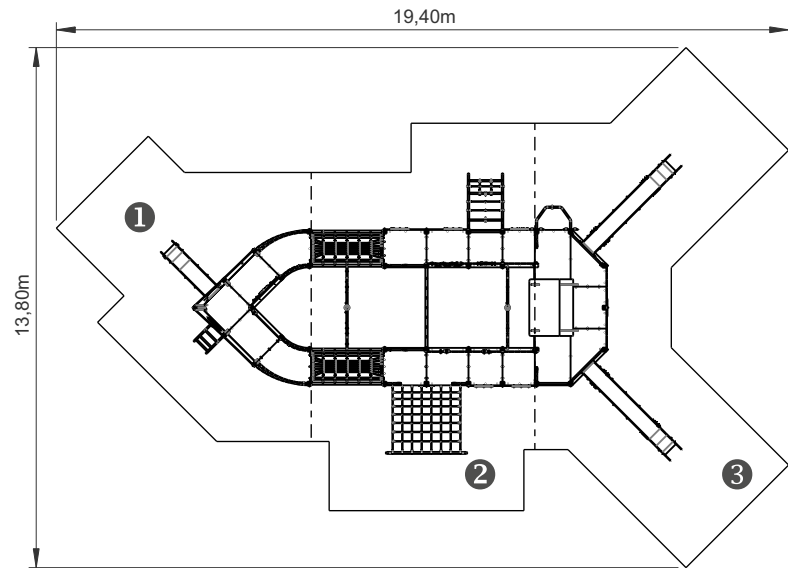
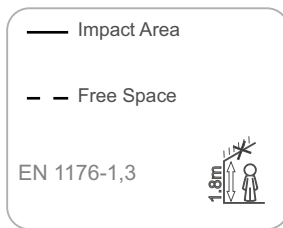





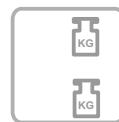
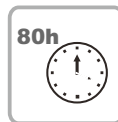

Equipment Information:



.....	1	2	3
	1,00	1,30	1,80
	37	56	55
	148		



Technical Information:

- 1 - Climbing Net  1,30m
- 2 - Slide  1,80m
- 3 - Fireman Rod  1,80m
- 4 - Treasure Map Game
- 5 - Steps  1,80m
- 6 - Mini Climbing Access
- 7 - Curved Ladder  1,00m
- 8 - Bridge  1,30m
- 9 - Octopus Game
- 10 - Compass Game
- 11 - Tunnel Game
- 12 - Command Cabin
- 13 - Fish Game
- 14 - Slide  1,00m
- 15 - Climbing Net  1,00m
- 16 - Turbine Game
- 17 - Rope Ladder  1,30m

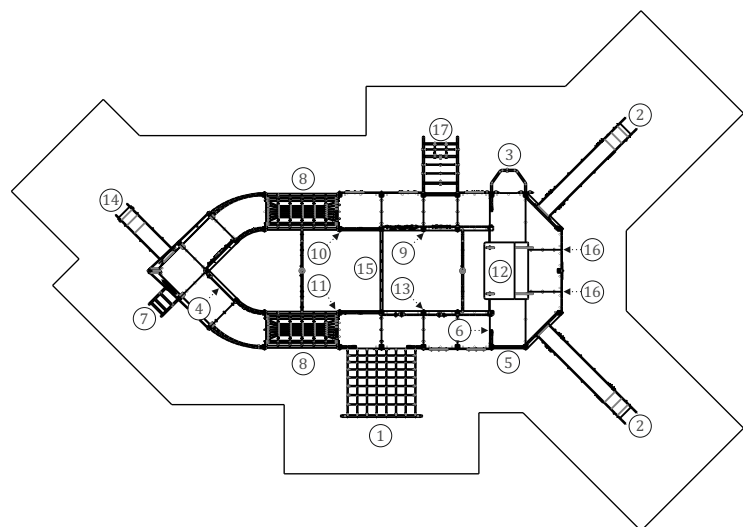

Technical Characteristics:



bragmaia®

Vertical posts

Aluminum: 90x90x2.5mm profile alloy 6063 and T66 treatment, which is an alloy extrusion excellence, exhibits excellent corrosion resistance with good surface finish. The T66 treatment in which this alloy is solubilized, tempered and artificially aged, aims to improve its mechanical properties. This is supplied at natural color with the option of being lacquered RAL according to customer needs;

Panels

HDPE: Monocolour/bicolour high density polyethylene. It is a polymer so it is characterized by its resistance to corrosion and chemical products. By its capacity of elasticity and lightweight, it offers high resistance to impacts, and, therefore, very difficult to break. The non-slip surface offers security to children and the synthetic base prevents grow of bacterias and fungus. No need for maintenance;

Net: Ø16mm steel ropes coated in reinforced Ø polypropylene fibers, connection accessories in HDPE with U.V. protection, fixing elements in galvanized hot steel;

Marine plywood: Non-slip, bonded with phenolic resins resistant to the weather and U.V., according to EL 314-2/classe 3 (DIN 68 TS TCIL3: BFU 100, BS 6566 PART 8 : WBP);

Plastic parts

Tunnel: Made of polypropylene corrugated tube in conformity with EN 13476;

Metal parts

Tubes:

Stainless steel: AISI 304, Ø40mm and Ø60mm;

Iron: Anticorrosive treatment of hot dip galvanizing in accordance with EN ISO 1461;

Sliding surface: Stainless steel plate AISI 304, bent and rolled from one piece;

Fixation System: Allow its placing on the ground avoiding the wood to come into direct contact with the soil. The bottom part of these fastening are anchored in the ground. Fabricated in galvanized steel;

Type B - Standard fixation system composed by steel base screwed to the ground with steel anchors;

Type C - Standard fixation system composed by posts applied directly in the ground with concrete;

Screws and accessories

Screws: Galvanized steel or optionally stainless steel AISI 304;

Capsules: PP Polypropylene plastic;



100% recyclable;

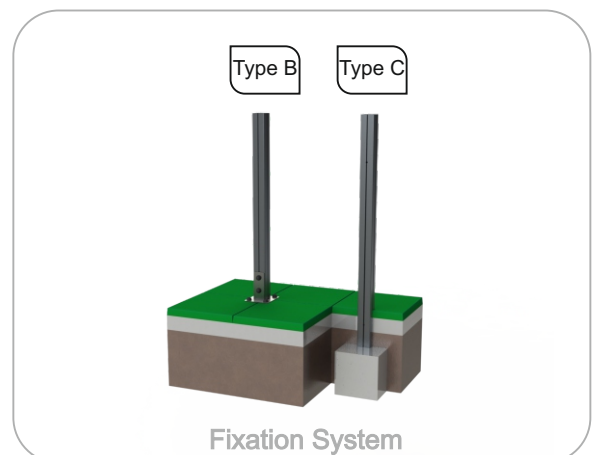

Playful Activities:



bragmaia®



Amuse: While they have fun, children acquire several capacities, since physical abilities to social interactions.



Socialize: The socialization and imagination are necessary in all games. All of it creates a relation between children and arouses the sense of coexistence and solidarity.



Play: Develops both patience, sharing and sportsmanship.



Sliding: A sloped surface allows the child to slide in great velocity, a sensation that makes him feel alive and learn to control his movements, reflexes and psychomotor abilities.



Climbing: A movement to develop children motor skills, body control, balance and coordination, which stimulates the motor capacity an own body security.



Glide: This activity provides a fascinating feeling which helps to develop balance and coordination by stimulating the nervous system.