

Play Tower with Swing, 1 Seat

PCM110621

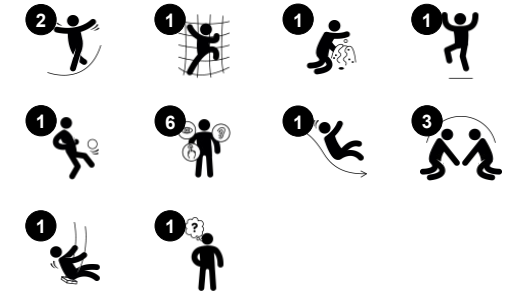

Item no. PCM110621-0902	
General Product Information	
Dimensions LxWxH	508x384x360 cm
Age group	3+
Play capacity (users)	7
Colour options	● ● ● ● ● ●



This play tower with a swing enhances physical play with opportunities for children to move around by climbing, stretching, sliding, and swinging. The structure motivates children by providing a variety of play activities physical and social play. Climbing strengthens muscles and helps to develop cross-coordination skills. This enhances a child's ability to use both

sides of their brain, and supports the internal structures that enable reading and thinking. Sliding is immensely thrilling and also supports posture and balance, important skills for young children as they grow. They are the basis for all other physical skills and help to build up confidence to navigate the world securely. Swinging is a favorite playground activity, that

is an instant attractor for children. With lots of activities embedded in the structure, children will play for a long time, enhancing their health and well-being.

Play Tower with Swing, 1 Seat

PCM110621



Swing seat

Physical: balance, coordination and spatial awareness are developed when swinging. These are necessary skills for judging distances and navigating. The swinging movement trains the arm, leg and core muscles, and strengthens bone density when jumping off. **Cognitive:** cause and effect understanding and thinking skills for younger children when swinging.



Climbing net

Physical: supports physical strength and cross-body coordination, which impacts coordination of the right and left part of brain, fundamental for other skills such as the ability to read.



Slide

Physical: sliding develops spatial awareness and a sense of balance. Furthermore, the core muscles are trained when sitting upright going down. **Social-Emotional:** empathy stimulated by turn-taking. **Cognitive:** young children develop their understanding of space, speed and distances when sliding down quickly.

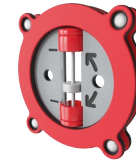

Timer

Social-Emotional: teams can each have a button to measure rounds, wins etc. The buttons support cooperation and teamwork. **Cognitive:** counting and registering support thinking skills such as logical thinking and sequencing. **Creative:** children can leave their mark, placing the timer in different positions.

Play Tower with Swing, 1 Seat

PCM110621

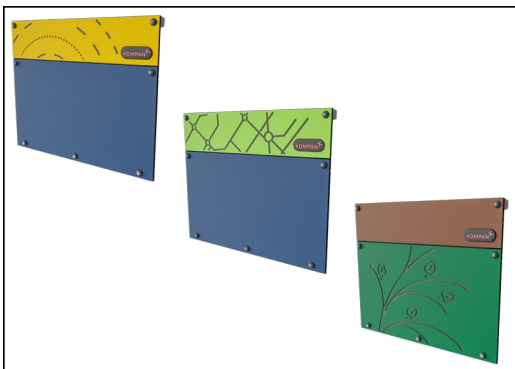

Panels of 19mm EcoCore™. EcoCore™ is a highly durable, eco friendly material, which is not only recyclable after use, but also consists of material produced from +95% recycled post consumer material from food packing waste.



All decks are supported by unique designed low-carbon aluminum profiles with multiple attachment options. The grey colored molded decks are made of 75% post-consumer waste PP material with a non-skid pattern and texture surface.



Main posts with hot dip galvanized steel footing are available in different materials: Pressure impregnated pine wood posts. Pre-galvanized inside and outside with powder coated top finish steel posts. Lead free aluminum with color anodized top finish. Greenline TexMade posts of 95% post-consumer recycled PE and textile waste.

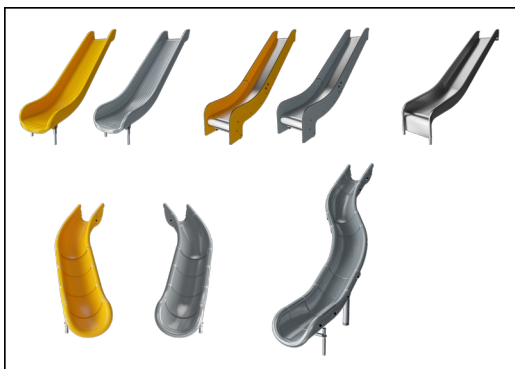

The slides can be chosen in different materials and colors: Straight or curved one-piece molded PE slides in yellow or grey color. Combined EcoCore™ sides and stainless-steel. Full stainless steel in one-piece design for more vandalism proof solutions.

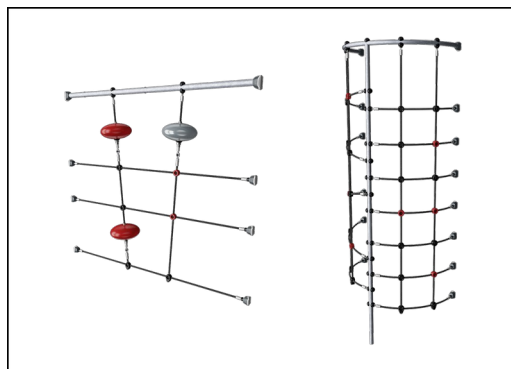

Ropes of UV-stabilized PES rope strands with inner steel cable reinforcement. The polyester yarn is made from +95% post-consumer materials and is inductively melted onto each strand.



The standard seats of KOMPAN swings is engineered for maximum safety and durability. The two component seat with a PP inner core and outside rubber is produced in one operation. The seats are available with swing chains of either hot dip galvanised steel or stainless steel for all swings heights.

Item no. PCM110621-0902

Installation Information

Max. fall height	145 cm
Safety surfacing area	37.1 m ²
Total installation time	13.0
Excavation volume	0.89 m ³
Concrete volume	0.04 m ³
Footing depth (standard)	85 cm
Shipment weight	462 kg
Anchoring options	Surface ✓ In-ground ✓

Warranty Information

EcoCore HDPE	Lifetime
PE slide	10 years
Post	10 years
PP Decks	10 years
Spare parts guaranteed	10 years



Sustainability Data

PCM110621



Cradle to Gate A1-A3	Total CO ₂ emission	CO ₂ e/kg	Recycled materials
	kg CO ₂ e	kg CO ₂ e/kg	%
PCM110621-0902	689.81	2.03	62.43

The overall framework applied for these factors is the Environmental Product Declaration (EPD), which quantifies "environmental information on the life cycle of a product and enable comparisons between products fulfilling the same function" (ISO, 2006). This follows the structure and applies a Life-Cycle Assessment approach to the entire Product stage from raw material through manufacturing (A1-A3))

Kompan A/S
 C.F. Tietgens Boulevard 32C
 DK-5220 Odense SØ
 Denmark



Verification of CO₂ calculation of: Play systems



Data version no. 2023-10-05

The CO₂ calculation and data are in compliance with the principles of a carbon footprint impact according to the GHG protocol (Greenhouse Gas Protocol), Scope 3, cradle to gate related to all individual components in the product category: "Play systems" represented by item no.: PCM200321-0950.

(Scope 3 emissions include emission sources in the upstream and downstream value chain).

Date: 30. October 2023 | Valid until: 30. October 2025

Verified by:

Julie Marie Vejsgaard Larsen, LCA & EPD Consultant

Verification based on report: Validation of CO₂ calculation of 9 categories of Kompan product line, version 1.0, prepared by: Bureau Veritas HSE, Denmark: Julie M. V. Larsen.

Publication date: 30. October 2023

By Bureau Veritas HSE
 www.bureauveritas.dk
 +45 7731 1000



Play Tower with Swing, 1 Seat

PCM110621

* Max fall height | ** Total height | *** Safety surfacing area

* Max fall height | ** Total height

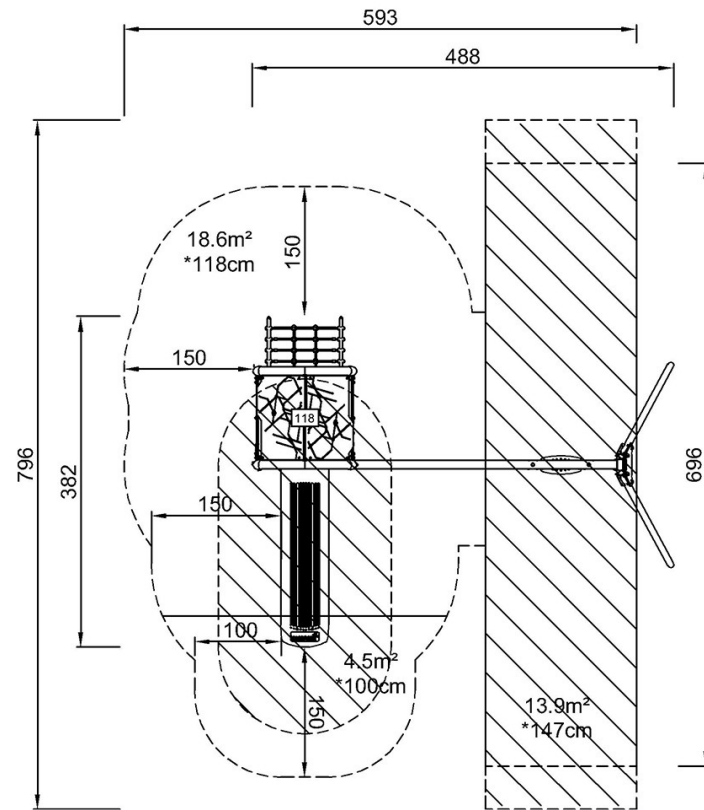

PCM110621
*147cm
**352cm
***37m²

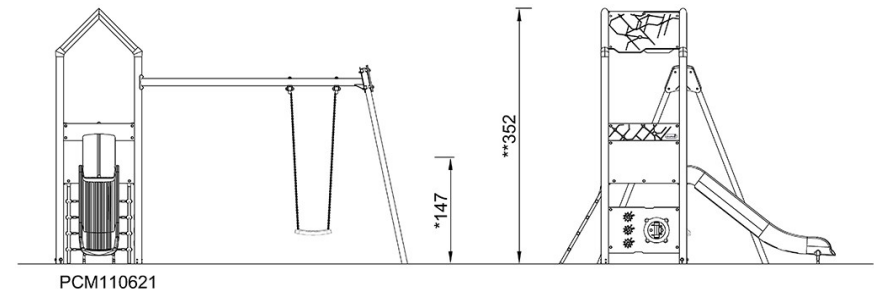

[Click to see TOP VIEW](#)

[Click to see SIDE VIEW](#)