

Pioneer

PCE200531

Item no. PCE200531-0602

General Product Information

Dimensions LxWxH	1027x476x340 cm
Age group	1+
Play capacity (users)	44
Colour options	

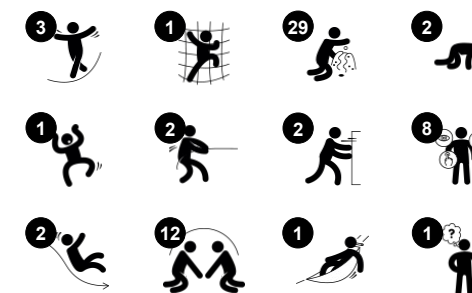

The Pioneer is an inclusive play journey that makes children go wow. Thanks to the rich variation of play activities, children will come back again and again. A ramp leads through varied tactile play events to a vast platform with two slides. This allows for access to an elevated level. From the other end of the play structure, an accessible stairway winds up to

the platform. On ground level there is a hammock, a desk for sand play, music panel and numerous tactile and fun features. Talk tubes allow fun contact across the structure. All of these activities train the child's logical thinking skills and creativity. The outside of the Pioneer offers three corners for exploratory play and a break from the wilder action of the

ramp. The transparency in the structure allows for all round communication.



Pioneer

PCE200531

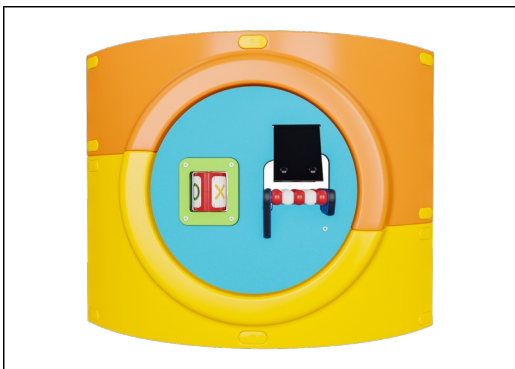

The Curved ELEMENTS panels are moulded of UV stabilised recyclable PE with multiple options for in-built play features that also ensures a strong panel solution. Straight panels are made of KOMPAN 19mm PE EcoCore™ which is a highly durable, ecofriendly and recyclable material.

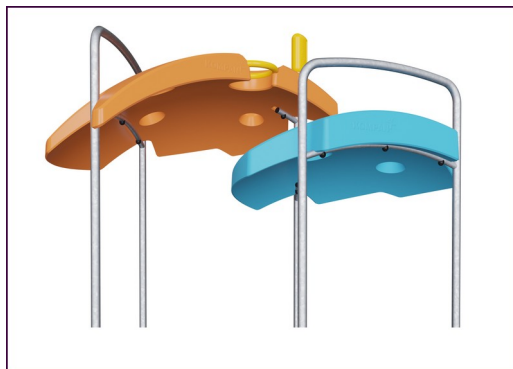

The ELEMENTS roofs are made of recyclable PE with a minimum wall thickness of 5 mm to ensure high durability in all climates around the world. The steel pipes are hot dip galvanised inside and outside for maximum durability.



ELEMENTS products are available in three different colour combinations: classic blue & green, blossom orange & yellow, nature lime and green.



The main posts are made of high quality pre-galvanized steel with powder coated top finish. Post tops are closed with caps of UV stabilized nylon (PA6). The grey colored molded decks are made of 75% post-consumer ocean waste PP material with a non-skid pattern and texture surface. All decks are supported by unique designed low-carbon aluminum profiles with multiple attachment options.

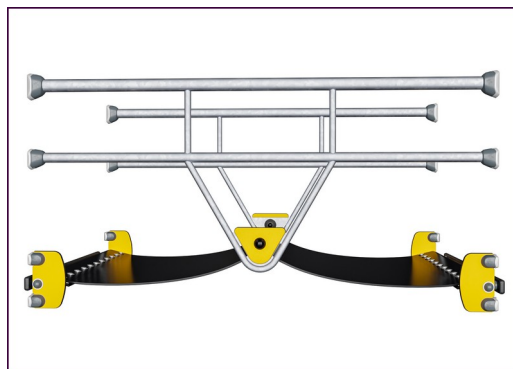

ELEMENTS rubber membranes are conveyor belt made of layers of rubber mixed of natural rubber and SBR rubber, and embedded with layers of armouring made of woven PE and PA. The thickness 8mm ensures high durability in any environment.

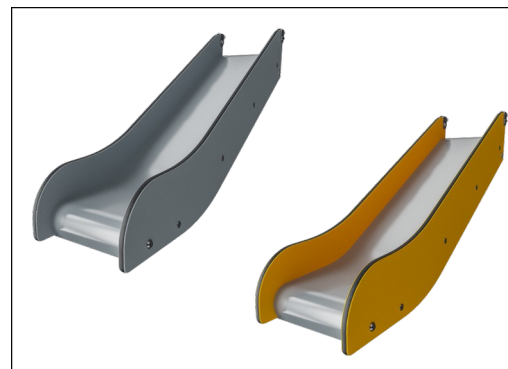

The special designed slide for under 2 year old's as specified in ASTM F2373 is made of EcoCore™ sides and a molded PE slide bed

Item no. PCE200531-0602

Installation Information

Max. fall height	100 cm
Safety surfacing area	69.9 m ²
Number of installers	2
Total installation time	42.3
Excavation volume	0.69 m ³
Concrete volume	0.17 m ³
Footing depth (standard)	60 cm
Shipment weight	1,450 kg
Anchoring options	Surface ✓ In-ground ✓

Warranty Information

EcoCore HDPE	Lifetime
Post	10 years
Curved panels	10 years
Membrane	2 years
Spare parts guaranteed	10 years





Cradle to Gate A1-A3	Total CO ₂ emission	CO ₂ e/kg	Recycled materials
	kg CO ₂ e	kg CO ₂ e/kg	%
PCE200531-0602	2,986.30	2.67	34.30

The overall framework applied for these factors is the Environmental Product Declaration (EPD), which quantifies "environmental information on the life cycle of a product and enable comparisons between products fulfilling the same function" (ISO, 2006). This follows the structure and applies a Life-Cycle Assessment approach to the entire Product stage from raw material through manufacturing (A1-A3))

Kompan A/S
 C.F. Tietgens Boulevard 32C
 DK-5220 Odense SØ
 Denmark



Validation of CO₂ calculation of: Play systems



Data version no. 2021-01-11

The CO₂ calculation and data are in compliance with the principles of a carbon footprint impact according to the GHG protocol (Greenhouse Gas Protocol), Scope 3, cradle to gate related to all individual components in the product category: "Play systems" represented by item no.: PCM200309-0010. (Scope 3 emissions include emission sources in the upstream and downstream value chain).

Date: 15. October 2021 | Valid until: 15. October 2023

Validated by:

Bente Hviid, Senior Consultant

Peter Bendtsen, Senior Consultant

Validation based on report: Validation of CO₂ calculation of play systems – Kompan, version 1.0, prepared by: Bureau Veritas HSE, Denmark: Bente Hviid and Peter Bendtsen.

Publication date: 15. October 2021

By Bureau Veritas HSE
 www.bureauveritas.dk
 +45 7731 1000



* Max fall height | ** Total height | *** Safety surfacing area

* Max fall height | ** Total height

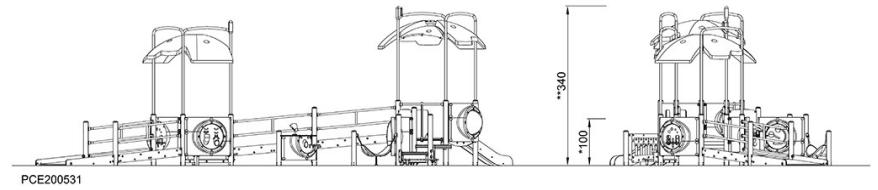
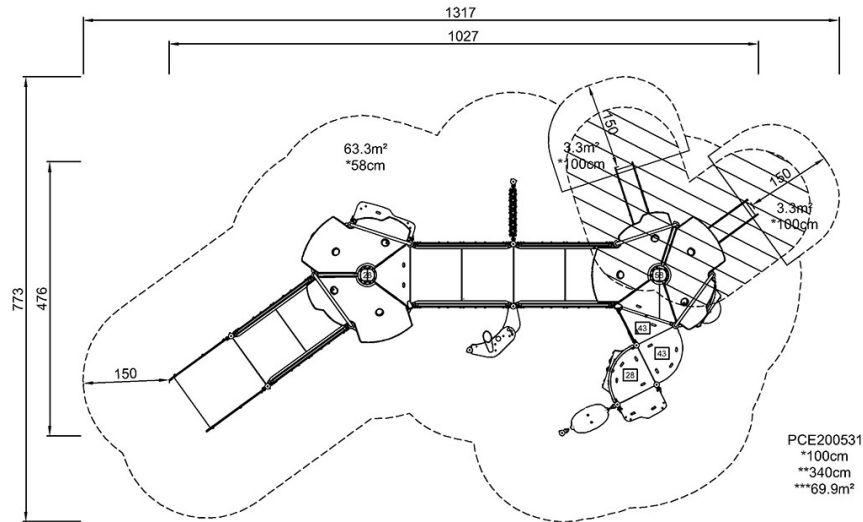

[Click to see TOP VIEW](#)

[Click to see SIDE VIEW](#)