

# Everest

PCE610221

Item no. PCE610221-0901

### General Product Information

Dimensions LxWxH	1578x1549x553 cm
Age group	4+
Play capacity (users)	103
Colour options	

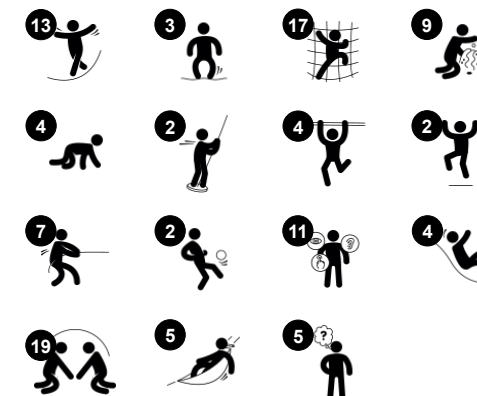

Everest is an awesome, thrilling ramped play unit that makes children want to come back again and again thanks to its vast variety of opportunities for fun. The physical, social-emotional and cognitive skills of children are trained when bouncing, climbing, sliding, swaying and gliding the Everest. Climbing trains cross-coordination and understanding

the sense of space, and the varied gliding and sliding egresses add thrills and develop balance. This makes the Everest a trainer of the ABC's of motor skills: Agility, Balance and Coordination, which help build the foundation for life skills like navigating traffic securely. On ground level, swaying and bouncing meeting points offer nice areas for retreat. Play panels

add explorative play options and train logical thinking. All in all, the Everest is the peak of play for all school age children.



Data is subject to change without prior notice.

# Everest

PCE610221



## Coroflex rope ladder

**Physical:** balance due to slight bounce of ropes, cross coordination and spatial awareness as well as upper body muscles when hanging with arms. This is especially important due to sedentary lifestyles of today's children. **Social-Emotional:** chill and socialize on horizontal ropes.



## Tic-tac-toe panel

**Social-Emotional:** stimulates communication and turn-taking skills. **Cognitive:** support rules understanding, strategic thinking. **Creative:** leaving marks when tumblers are left in new positions.



## Banister bars

**Physical:** coordination is supported when going down, as well as arm and core muscles. Landing strengthens bone density, which is built for life in childhood. **Social-Emotional:** turn-taking and risk-taking.



## Twisted net

**Physical:** the big, twisted meshes allow for varied climbing and crawling through, supporting the development of proprioception, spatial awareness, cross coordination, and muscle strength. **Social-Emotional:** the partly horizontal meshes allow more children to sit together and talk.



## Double slide

**Physical:** sliding develops spatial awareness and a sense of balance. Furthermore, the core muscles are trained when sitting upright going down. **Social-Emotional:** invites socializing, supports parent-child and peer-to-peer play.



## Membrane bridge

**Physical:** agility, balance and coordination, force of movement and sense of effort. Development of bone density when jumping. **Social-Emotional:** turn-taking, problem solving and cooperation when bouncing others. Relaxation when lying or sitting, being bounced by others. **Cognitive:** understanding of cause and effect, logical thinking.



## Large hammock

**Physical:** sense of balance when swaying, body pressure when lying. Support users lying or seated. **Social-Emotional:** meeting, pushing friends gently back and forth, turn-taking.

# Everest

PCE610221

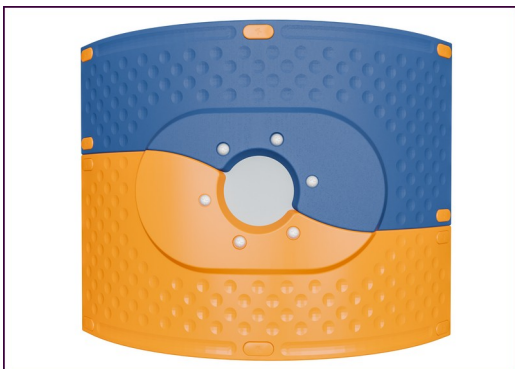

The Curved ELEMENTS panels are moulded of UV stabilised recyclable PE using 33% post-consumer recycled material. With multiple options for in-build play features that also ensures a strong panel solution. Straight panels are made of KOMPAN 19mm HDPE EcoCore™ which is a highly durable, ecofriendly and recyclable material made from +95% PCM.



The climbing elements displayed are moulded from 33% post-consumer recycled materials in one piece, with a minimum 5mm wall thickness. The climbing elements are made of recyclable PE which has a high impact resistance across a wide temperature span which ensures vandal resistance in all locations.

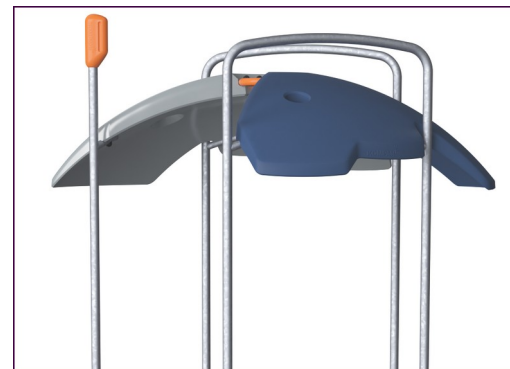

The ELEMENTS roofs are made of recyclable PE made from 33% post consumer recycled materials with a minimum wall thickness of 5 mm to ensure high durability in all climates around the world. The steel pipes are hot dip galvanised inside and outside for maximum durability.

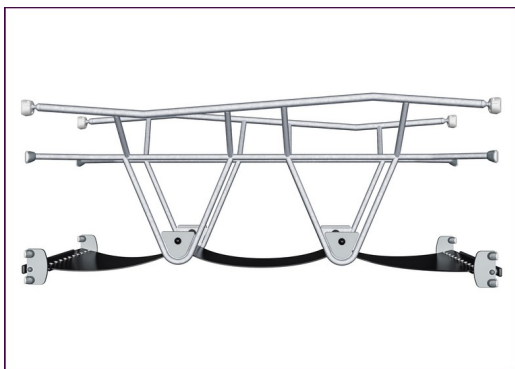

ELEMENTS rubber membranes are conveyor belt made of layers of rubber mixed of natural rubber and SBR rubber, and embedded with layers of armouring made of woven PE and PA. The thickness 8mm ensures high durability in any environment.



The main posts are made of high quality pregalvanized steel with powder coated top finish. Post tops are closed with caps of UV stabilized nylon (PA6). The grey colored molded decks are made of 75% post-consumer waste PP material with a non-skid pattern and texture surface. All decks are supported by unique designed low-carbon aluminum profiles with multiple attachment options.



ELEMENTS ropes has six-stranded steel wires and a steel wire core. Each strand is tightly wrapped with PES yarn, which is made from +95% post consumer materials. The yarn is then melted onto each individual strand making the ropes highly wear- and vandalism-resistant.

Item no. PCE610221-0901

### Installation Information

Max. fall height	273 cm
Safety surfacing area	273.0 m <sup>2</sup>
Total installation time	118.8
Excavation volume	2.17 m <sup>3</sup>
Concrete volume	0.38 m <sup>3</sup>
Footing depth (standard)	90 cm
Shipment weight	4,667 kg
Anchoring options	Surface ✓ In-ground ✓

### Warranty Information

Curved panels	10 years
EcoCore HDPE	Lifetime
Membrane	2 years
Post	10 years
Spare parts guaranteed	10 years



# Sustainability Data

PCE610221



Cradle to Gate A1-A3	Total CO <sub>2</sub> emission	CO <sub>2</sub> e/kg	Recycled materials
	kg CO <sub>2</sub> e	kg CO <sub>2</sub> e/kg	%
<b>PCE610221-0901</b>	8,927.20	2.52	46.72

The overall framework applied for these factors is the Environmental Product Declaration (EPD), which quantifies "environmental information on the life cycle of a product and enable comparisons between products fulfilling the same function" (ISO, 2006). This follows the structure and applies a Life-Cycle Assessment approach to the entire Product stage from raw material through manufacturing (A1-A3))

**Kompan A/S**  
 C.F. Tietgens Boulevard 32C  
 DK-5220 Odense SØ  
 Denmark

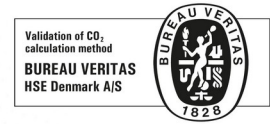

## Verification of CO<sub>2</sub> calculation of: Play systems



Data version no. 2023-10-05

The CO<sub>2</sub> calculation and data are in compliance with the principles of a carbon footprint impact according to the GHG protocol (Greenhouse Gas Protocol), Scope 3, cradle to gate related to all individual components in the product category: "Play systems" represented by item no.: PCM200321-0950.

(Scope 3 emissions include emission sources in the upstream and downstream value chain).

**Date: 30. October 2023 | Valid until: 30. October 2025**

Verified by:

Julie Marie Vejsgaard Larsen, LCA & EPD Consultant

Verification based on report: Validation of CO<sub>2</sub> calculation of 9 categories of Kompan product line, version 1.0, prepared by: Bureau Veritas HSE, Denmark: Julie M. V. Larsen.

**Publication date: 30. October 2023**

By Bureau Veritas HSE  
 www.bureauveritas.dk  
 +45 7731 1000



\* Max fall height | \*\* Total height | \*\*\* Safety surfacing area

\* Max fall height | \*\* Total height

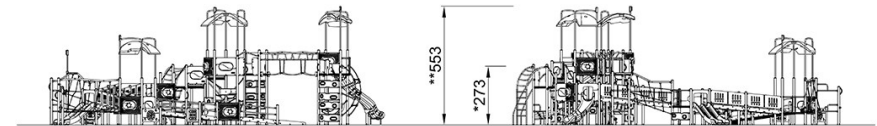
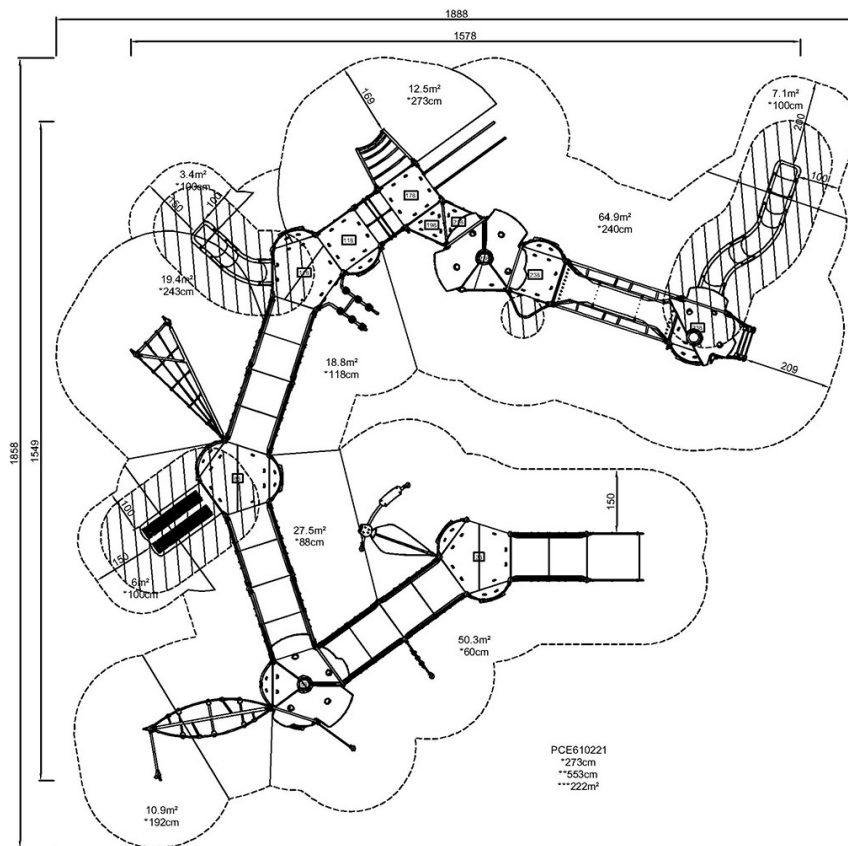

[Click to see TOP VIEW](#)

[Click to see SIDE VIEW](#)