

Palace & Fortress with ADA Stairs

MSC6416

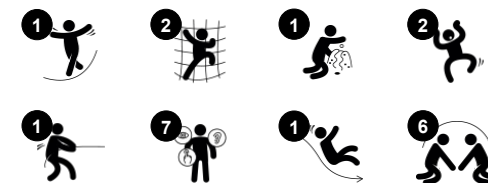

Item no. MSC641600-3717P	
General Product Information	
Dimensions LxWxH	508x376x288 cm
Age group	2+
Play capacity (users)	19
Colour options	



WOW! The Palace & Fortress themes appeal to children's urge for dramatic play stories. The ground level den, and even the dungeon invites a break with friends. There is a lion side and a unicorn side, inspiring play stories. Thanks to the two-sided panels and themes and the wide accessible stairway, this is play equipment suitable for all. The wide choice of climbing

elements and the slide enhance motor skills, such as cross-coordination and balance, important for navigating the world confidently. The meeting points are many, as the Palace and Fortress can be played on all sides. From the watch point on elevated level, you can meet with friends and enjoy the view. A megaphone also makes possible shouting out

messages. All in all, the social play invitation in the Palace and Fortress is immense. Children meet, greet and play, making friends for life.



Data is subject to change without prior notice.

Palace & Fortress with ADA Stairs

MSC6416



Balcony

Social-Emotional: the balcony invites meetings and interaction with people on ground level.



Accessible stairway

Physical: climbing the accessible stairway is for all and supports cross coordination as well as arm and leg muscles. For young children, walking stairs and alternating feet is developed. **Social-Emotional:** room for active breaks and adult helpers. An inclusive space.



Megaphone

Social-Emotional: inspires communication and turn-taking skills. **Cognitive:** distortion of sound evokes curiosity and stimulates an understanding of cause and effect.



Curved climbing wall

Physical: children develop their cross-body coordination, proprioception and leg, arm and hand strength. Climbing on a curved surface is an extra challenge to muscles.



Desk

Social-Emotional: fine meeting place and a space creator. Sharing and cooperation from both sides create a social scenario that supports communication and cooperation.



Den

Physical: crawling through the possible openings trains spatial awareness. **Social-Emotional:** the enclosed space invites social play for two or three children.



Slide

Physical: sliding develops spatial awareness and a sense of balance. Furthermore, the core muscles are trained when sitting upright going down. **Social-Emotional:** empathy stimulated by turn-taking. **Cognitive:** young children develop their understanding of space, speed and distances when sliding down quickly.

Palace & Fortress with ADA Stairs

MSC6416



Panels of 19mm EcoCore™. EcoCore™ is a highly durable, eco friendly material, which is not only recyclable after use, but also consists of material produced from +95% recycled post consumer material from food packing waste.



All floors are made of High-Pressure Laminate HPL with a thickness 17.8mm and non skid surface texture according to EN 438-6. KOMPAN HPL has high wearing strength to ensure long lifetime in all climates.

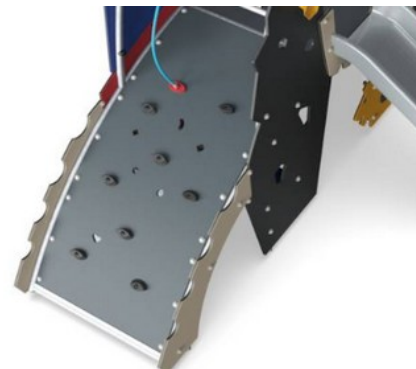

Curved climbing wall is made of Ekogrip® panel that consist of a 15mm thick PE base with 3 mm top-layer of soft rubber with a non-skid effect.

Item no. MSC641600-3717P

Installation Information

Max. fall height	120 cm
Safety surfacing area	37.0 m ²
Total installation time	22.1
Excavation volume	0.87 m ³
Concrete volume	0.00 m ³
Footing depth (standard)	90 cm
Shipment weight	754 kg
Anchoring options	In-ground ✓ Surface ✓

Warranty Information

EcoCore HDPE	Lifetime
Hot dip galvanised steel	Lifetime
HPL decks	15 years
Ropes & nets	10 years
Spare parts guaranteed	10 years



Molded PE slides made with 33% post-consumer materials in different colors in one-piece design with a wall thickness of minimum 5mm. The PE is tested for UV stability and has excellent impact strength and it is usable within a large temperature span.

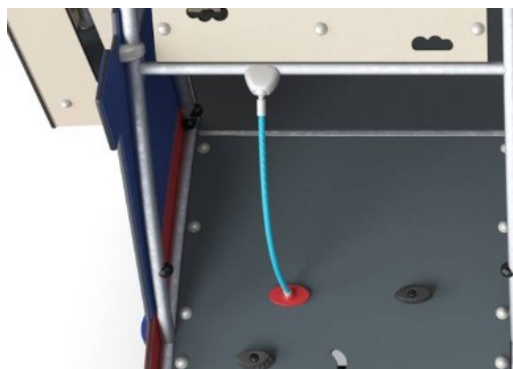

Ropes are made of UV-stabilized PP rope strands with inner steel cable reinforcement to obtain good wear and tear resistance.

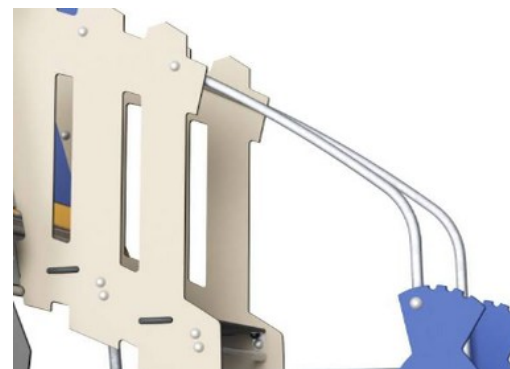

The steel surfaces are hot dip galvanised inside and outside with lead free zinc. The galvanisation has excellent corrosion resistance in outside environments and requires low maintenance.



Sustainability Data

MSC6416



Cradle to Gate A1-A3	Total CO ₂ emission	CO ₂ e/kg	Recycled materials
	kg CO ₂ e	kg CO ₂ e/kg	%
MSC641600-3717P	1,296.10	2.15	53.34

The overall framework applied for these factors is the Environmental Product Declaration (EPD), which quantifies "environmental information on the life cycle of a product and enable comparisons between products fulfilling the same function" (ISO, 2006). This follows the structure and applies a Life-Cycle Assessment approach to the entire Product stage from raw material through manufacturing (A1-A3))

Kompan A/S
 C.F. Tietgens Boulevard 32C
 DK-5220 Odense SØ
 Denmark



Verification of CO₂ calculation of: Themed play systems



Data version no. 2023-10-05

The CO₂ calculation and data are in compliance with the principles of a carbon footprint impact according to the GHG protocol (Greenhouse Gas Protocol), Scope 3, cradle to gate related to all individual components in the product category: "Themed play systems" represented by item no.: MSC641100-3717P.

(Scope 3 emissions include emission sources in the upstream and downstream value chain).

Date: 30. October 2023 | Valid until: 30. October 2025

Verified by:

Julie Marie Vejsgaard Larsen, LCA & EPD Consultant

Verification based on report: Validation of CO₂ calculation of 9 categories of Kompan product line, version 1.0, prepared by: Bureau Veritas HSE, Denmark: Julie M. V. Larsen.

Publication date: 30. October 2023

By Bureau Veritas HSE
 www.bureauveritas.dk
 +45 7731 1000



Palace & Fortress with ADA Stairs

MSC6416

* Max fall height | ** Total height | *** Safety surfacing area

* Max fall height | ** Total height

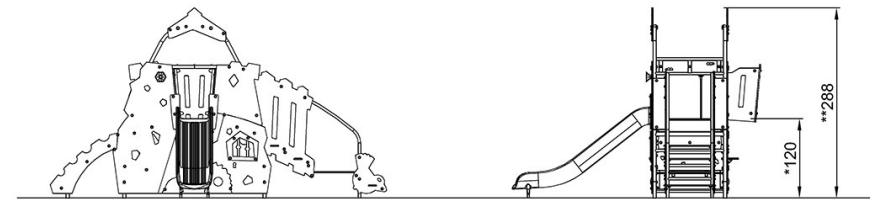
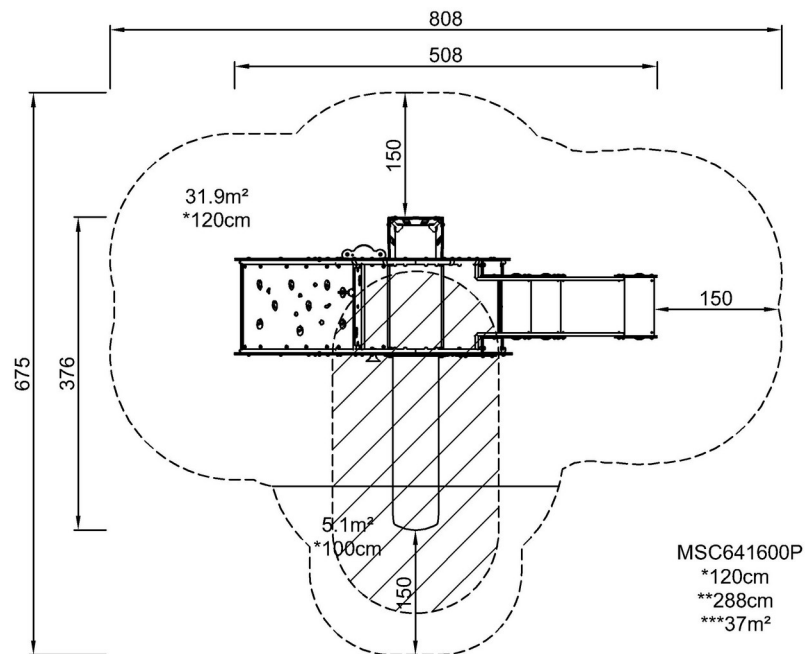

[Click to see TOP VIEW](#)

[Click to see SIDE VIEW](#)