

Jungle & Ocean with Net Tower

MSC6404

Item no. MSC640400-3717P

General Product Information

Dimensions LxWxH	738x433x286 cm
Age group	2+
Play capacity (users)	30
Colour options	●

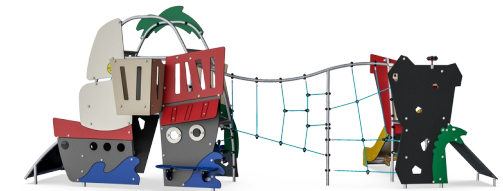
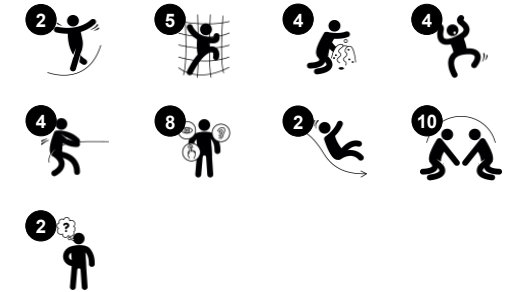
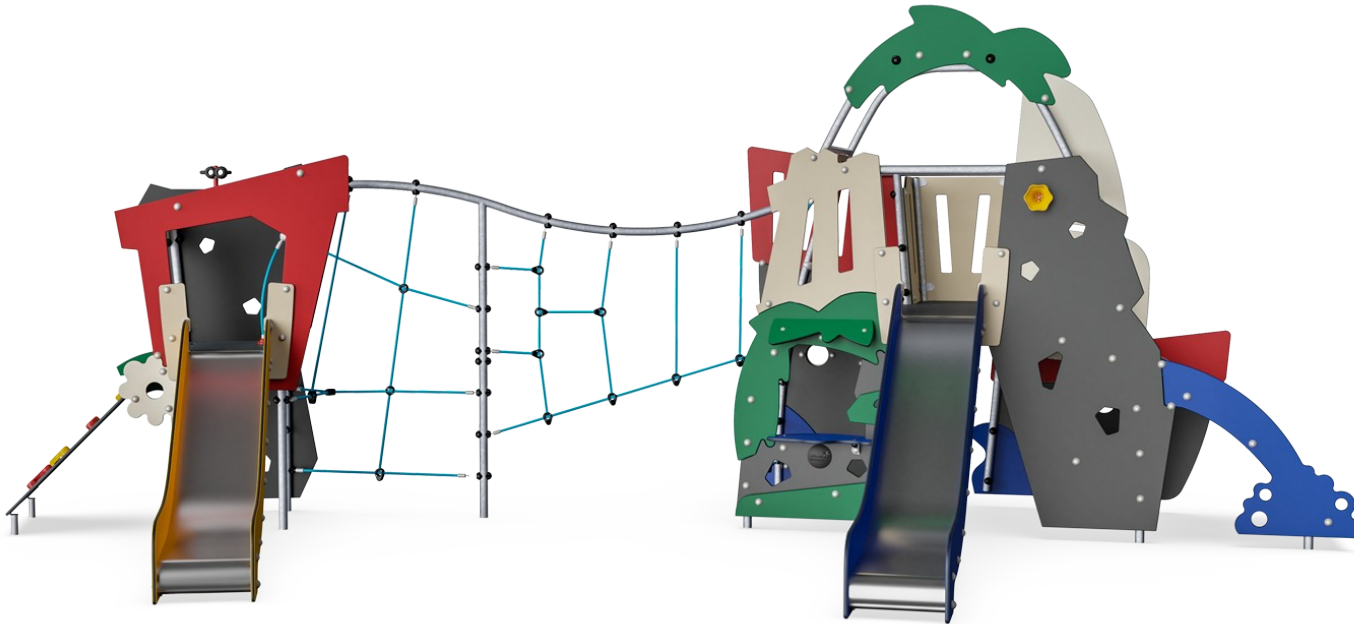

WOW! The roomy Jungle & Ocean themes appeal to children's dramatic play stories. The ground-level den invites a break with friends. There is a Jungle side and an Ocean side, inspiring vigorous play stories. Thanks to the two-sided themed panels and the varied climbers: curved, straight and net climbers, there are challenges for a wide user group. The

climbing events and the slides train motor skills, such as cross-coordination and balance, important for navigating the world confidently. There are many meeting points as the Jungle & Ocean can be played in from all sides. The huge net adds volume and active meeting. From the upper level, children can communicate with those on the ground level.

All in all, the social play invitation in the Jungle & Ocean is immense. Children meet, greet and play, making friends for life.

Jungle & Ocean with Net Tower

MSC6404



Megaphone

Social-Emotional: inspires communication and turn-taking skills. **Cognitive:** distortion of sound evokes curiosity and stimulates an understanding of cause and effect.

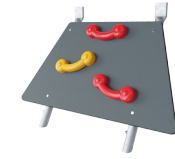
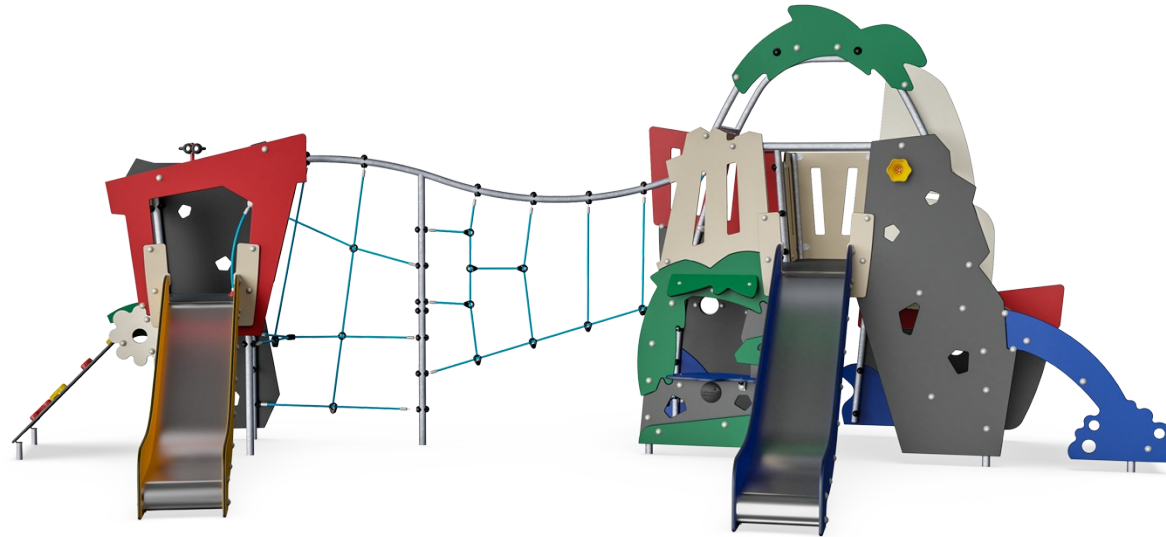

Rock climber

Physical: supports cross coordination and leg, arm and hand strength. **Social-Emotional:** the inclination makes climbing feel secure, especially for younger children.



Climbing net

Physical: children develop cross-body coordination and muscle strength. The asymmetry of the net challenges the children's climbing.



Balcony

Social-Emotional: the balcony invites meetings and interaction with people on ground level.



Den

Physical: crawling through the possible openings trains spatial awareness. **Social-Emotional:** the enclosed space invites social play for two or three children.



Binoculars

Cognitive: the binoculars set a tangible theme and thus spur dramatic play. Dramatic play is a great trainer of language and communication skills. **Creative:** the binoculars can be turned in all directions. Looking through them gives a new perspective on the world.



Slide

Physical: sliding develops spatial awareness and a sense of balance. Furthermore, the core muscles are trained when sitting upright going down. **Social-Emotional:** empathy stimulated by turn-taking. **Cognitive:** young children develop their understanding of space, speed and distances when sliding down quickly.

Jungle & Ocean with Net Tower

MSC6404



Panels of 19mm EcoCore™. EcoCore™ is a highly durable, eco friendly material, which is not only recyclable after use, but also consists of material produced from +95% recycled post consumer material from food packing waste.

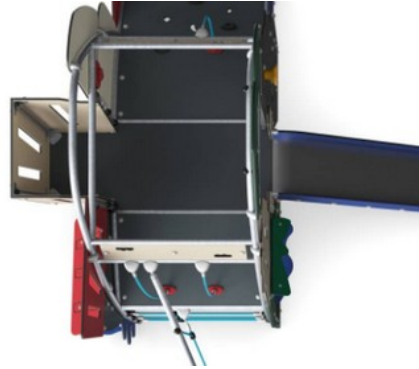

All floors are made of High-Pressure Laminate HPL with a thickness 17.8mm and non skid surface texture according to EN 438-6. KOMPAN HPL has high wearing strength to ensure long lifetime in all climates.

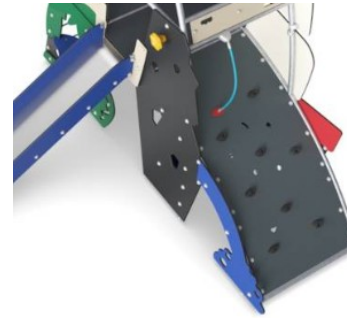

Curved climbing wall is made of Ekogrip® panel that consist of a 15mm thick PE base with 3 mm top-layer of soft rubber with a non-skid effect.



The slide is made of combined EcoCore™ sides and stainless steel slide bed t=2mm.

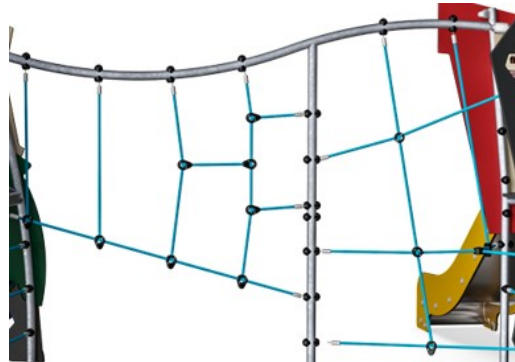

Climbing nets are made of UV-stabilised PP rope with inner steel cable reinforcement. The rope is induction treated to obtain maximum fixation between steel and rope which provides excellent wear and tear resistance. All rope connectors are made of 100% recyclable PA material.



The steel surfaces are hot dip galvanised inside and outside with lead free zinc. The galvanisation has excellent corrosion resistance in outside environments and requires low maintenance.

Item no. MSC640400-3717P

Installation Information

Max. fall height	193 cm
Safety surfacing area	51.1 m ²
Total installation time	31.7
Excavation volume	1.50 m ³
Concrete volume	0.00 m ³
Footing depth (standard)	90 cm
Shipment weight	1,036 kg
Anchoring options	In-ground ✓ Surface ✓

Warranty Information

EcoCore HDPE	Lifetime
Hot dip galvanised steel	Lifetime
HPL decks	15 years
Ropes & nets	10 years
Spare parts guaranteed	10 years



Sustainability Data

MSC6404

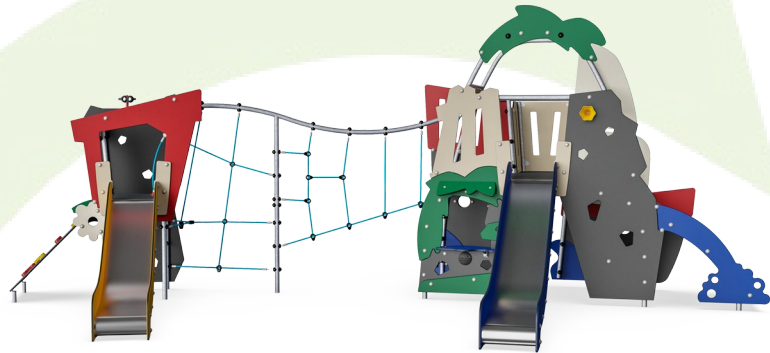

Cradle to Gate A1-A3	Total CO ₂ emission	CO ₂ e/kg	Recycled materials
	kg CO ₂ e	kg CO ₂ e/kg	%
MSC640400-3717P	1,795.37	2.28	57.50

The overall framework applied for these factors is the Environmental Product Declaration (EPD), which quantifies "environmental information on the life cycle of a product and enable comparisons between products fulfilling the same function" (ISO, 2006). This follows the structure and applies a Life-Cycle Assessment approach to the entire Product stage from raw material through manufacturing (A1-A3))

Kompan A/S
 C.F. Tietgens Boulevard 32C
 DK-5220 Odense SØ
 Denmark



Verification of CO₂ calculation of: Themed play systems



Data version no. 2023-10-05

The CO₂ calculation and data are in compliance with the principles of a carbon footprint impact according to the GHG protocol (Greenhouse Gas Protocol), Scope 3, cradle to gate related to all individual components in the product category: "Themed play systems" represented by item no.: MSC641100-3717P.

(Scope 3 emissions include emission sources in the upstream and downstream value chain).

Date: 30. October 2023 | Valid until: 30. October 2025

Verified by:

Julie Marie Vejsgaard Larsen, LCA & EPD Consultant

Verification based on report: Validation of CO₂ calculation of 9 categories of Kompan product line, version 1.0, prepared by: Bureau Veritas HSE, Denmark: Julie M. V. Larsen.

Publication date: 30. October 2023

By Bureau Veritas HSE
 www.bureauveritas.dk
 +45 7731 1000



Jungle & Ocean with Net Tower

MSC6404

* Max fall height | ** Total height | *** Safety surfacing area

* Max fall height | ** Total height

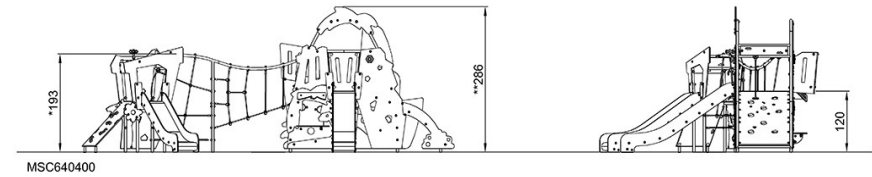
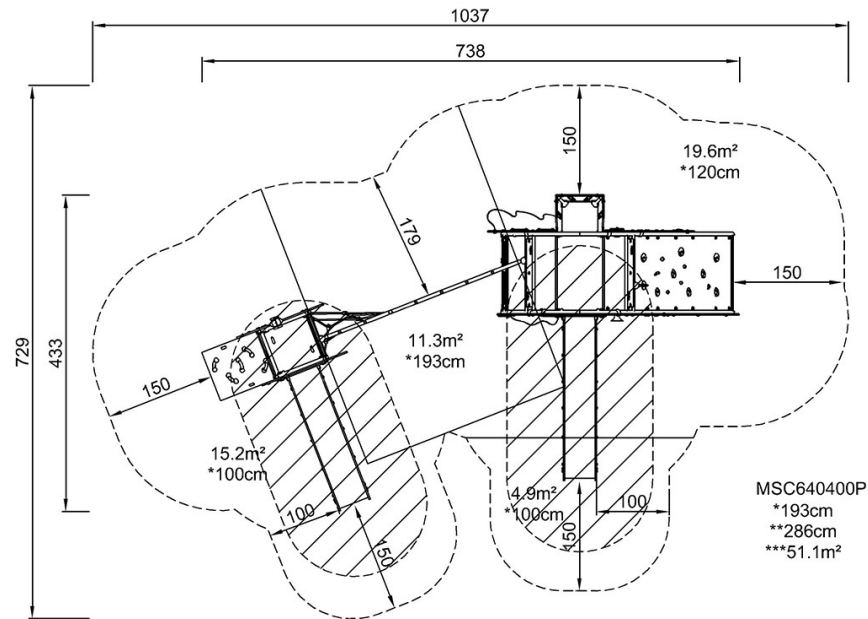

[Click to see TOP VIEW](#)

[Click to see SIDE VIEW](#)