

Crazy Dragon

M113

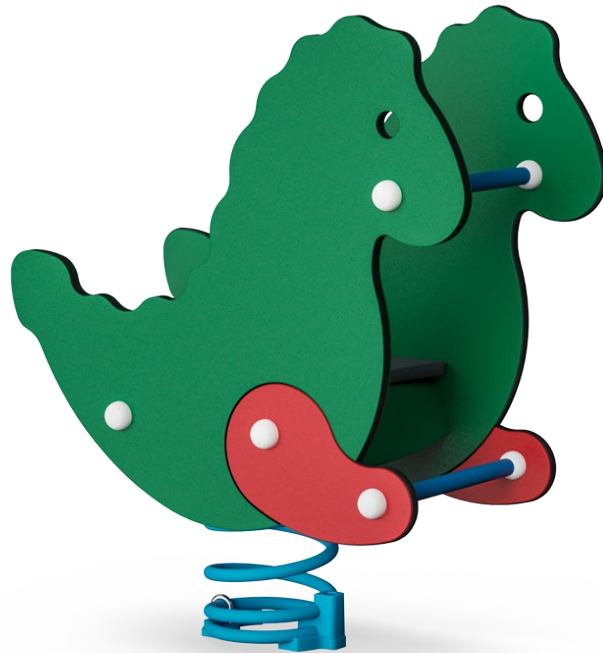

Rocking on the Crazy Dragon is a wildly attractive playground activity that children will return to again and again. Children are able to control the play by moving their bodies to make the Dragon rock. They will feel delighted to have the dragon respond to their movements. The two sides support the seated position, and the foot and hand holds provide a stable point

to stem feet and hands from, to create the movement. This is not only fun, but is also good for physical and cognitive development. When children begin to learn the connections between their bodies and their movements, they begin to make cognitive connections to a range of body movements and sensations. The dragon theme will be attractive to the child's

imagination, and will encourage wonderful physical and imaginative play.

Item no. M11315-01P	
General Product Information	
Dimensions LxWxH	36x75x89 cm
Age group	1+
Play capacity (users)	1
Colour options	

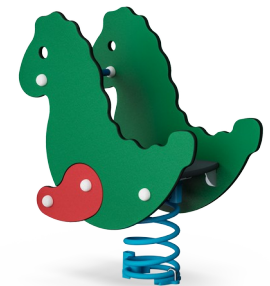

Crazy Dragon

M113



Theme

Cognitive: suggests a theme and supports dramatic play, which stimulates language and communication skills.

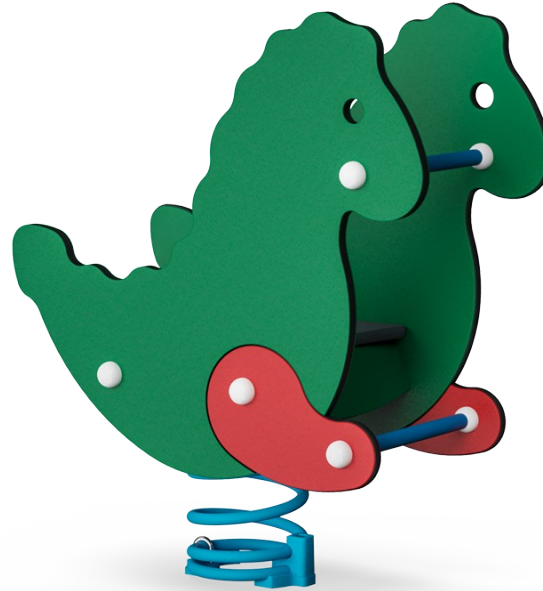

Foot support

Physical: the possibility of footrest supports intensive rocking. Rocking stimulates the senses of balance and space that are fundamental in managing the world securely.



Handhold

Physical: the vertical handgrips ensure a firm grip at different heights, necessary for rocking intensely. This trains hand and arm muscles.



Rocking spring

Physical: response to movements adds to spatial awareness and sense of balance. These are fundamental motor skills that help the child's ability to sit still on a chair which takes a good sense of balance. **Cognitive:** trains the understanding of cause and effect: when I move my body, the spring responds with movement.

Crazy Dragon

M113



Panels of 19mm EcoCore™. EcoCore™ is a highly durable, eco friendly material, which is not only recyclable after use, but also consists of material produced from +95% recycled post consumer material from food packing waste.



KOMPAN Springs are made of high quality spring steel according to EN10270. The springs are cleaned by phosphating before they are painted with an epoxy primer and a polyester powder coating as top finish. The springs are fixed by unique anti pinch fittings for maximum safety and long lifetime.



The springs are fixed by unique anti pinch fittings for maximum safety and long lifetime.

Item no. M11315-01P	
Installation Information	
Max. fall height	60 cm
Safety surfacing area	7.4 m ²
Total installation time	1.0
Excavation volume	0.19 m ³
Concrete volume	0.00 m ³
Footing depth (standard)	45 cm
Shipment weight	40 kg
Anchoring options	In-ground ✓ Surface ✓
Warranty Information	
EcoCore HDPE	Lifetime
Hot dip galvanised steel	Lifetime
Spare parts guaranteed	10 years
Springs	5 years



Platform and seats are made of HPL with a thickness of 17,8mm with a very high wearing strength and a unique KOMPAN nonskid surface texture.

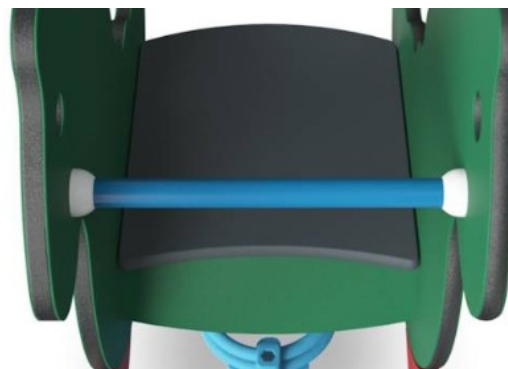

Handle is made of polypropylene PP with excellent impact strength and usable within a large temperature span.



Sustainability Data

M113

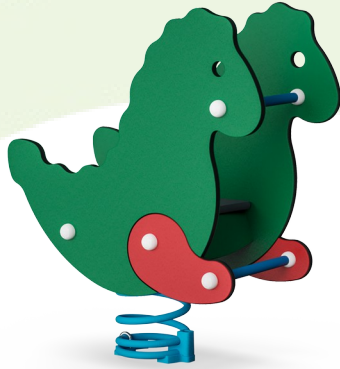

Cradle to Gate A1-A3	Total CO ₂ emission	CO ₂ e/kg	Recycled materials
	kg CO ₂ e	kg CO ₂ e/kg	%
M11315-01P	74.48	2.10	56.95

The overall framework applied for these factors is the Environmental Product Declaration (EPD), which quantifies "environmental information on the life cycle of a product and enable comparisons between products fulfilling the same function" (ISO, 2006). This follows the structure and applies a Life-Cycle Assessment approach to the entire Product stage from raw material through manufacturing (A1-A3))

Kompan A/S
 C.F. Tietgens Boulevard 32C
 DK-5220 Odense SØ
 Denmark



Verification of CO₂ calculation of: Freestanding play equipment



Data version no. 2023-10-05

The CO₂ calculation and data are in compliance with the principles of a carbon footprint impact according to the GHG protocol (Greenhouse Gas Protocol), Scope 3, cradle to gate related to all individual components in the product category: "Freestanding play equipment" represented by item no.: GXY916012-3417.

(Scope 3 emissions include emission sources in the upstream and downstream value chain).

Date: 30. October 2023 | Valid until: 30. October 2025

Verified by:

Julie Marie Vejsgaard Larsen, LCA & EPD Consultant

Verification based on report: Validation of CO₂ calculation of 9 categories of Kompan product line, version 1.0, prepared by: Bureau Veritas HSE, Denmark: Julie M. V. Larsen.

Publication date: 30. October 2023

By Bureau Veritas HSE
 www.bureauveritas.dk
 +45 7731 1000



Crazy Dragon

M113

* Max fall height | ** Total height | *** Safety surfacing area

* Max fall height | ** Total height

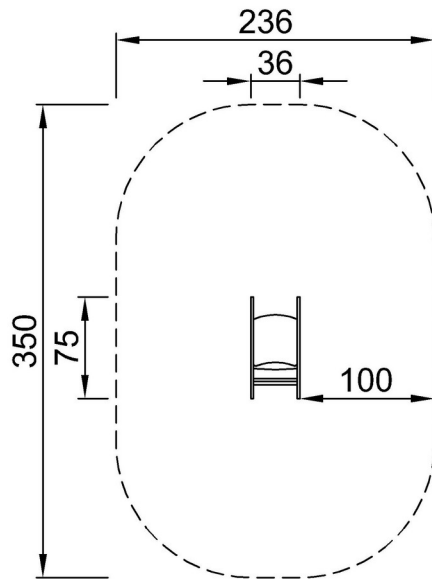

M11315P
*60cm
**89cm
***7.4m²

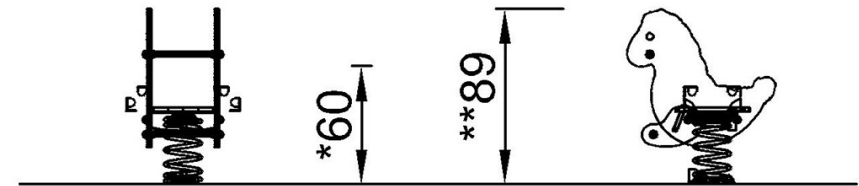

M11315

[Click to see TOP VIEW](#)

[Click to see SIDE VIEW](#)