

Triple Tower with Bridges

KPL3009

KOMPAN
Let's play



Item no. KPL300911-0601

General Product Information

Dimensions LxWxH	291x266x214 cm
Age group	1+
Play capacity (users)	12
Colour options	

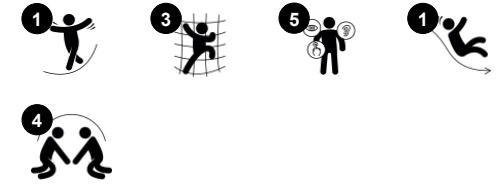

The Triple Tower with Bridges is a magnificent play venue for toddlers. It invites physical and social play. The combination of play events ensures hours and days of play, again and again. The varied accesses and the transparency of the structure allow for all to benefit from play, balance, coordination and spatial awareness are the main physical play

thrills: balancing up the inclined bridge is fun, and jumping down to and running over the straight bridge further stimulates the sense of space. Apart from being great fun, this is a fundament for managing the world securely, avoiding falls. The balance of more thrilling and more well-known play activities makes the Triple Tower with bridges a versatile challenge

for younger children. They will meet and turn-take in play, building up social-emotional skills, and friendships.



Data is subject to change without prior notice.

Triple Tower with Bridges

KPL3009



Rock climber

Physical: supports cross coordination and leg, arm and hand strength. **Social-Emotional:** the inclination makes climbing feel secure, especially for younger children.



Climb bridge

Physical: the skid-preventive cross-bars function as support for toddlers going up and down, supporting spatial awareness.



Bridge

Physical: cross coordination, spatial awareness. **Social-Emotional:** transparency invite cooperation with children on the outside.



Stair ladder

Physical: cross coordination is used, supporting the cooperation of the left and right halves of the brain, which is necessary for reading. For young children, spatial awareness is trained when walking stairs.



Slide

Physical: sliding develops spatial awareness and a sense of balance. Furthermore, the core muscles are trained when sitting upright going down. **Social-Emotional:** empathy stimulated by turn-taking. **Cognitive:** young children develop their understanding of space, speed and distances when sliding down quickly.

Triple Tower with Bridges

KPL3009



Panels of 19mm EcoCore™. EcoCore™ is a highly durable, eco friendly material, which is not only recyclable after use, but also consists of material produced from +95% recycled post consumer material from food packing waste.

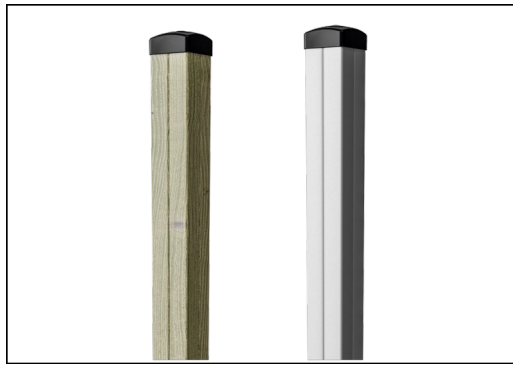

The main tower posts of either pine wood or aluminium are all equipped with hot dip galvanised steel footings. The steel footings elevates the posts 20mm from ground level to avoid contact with surfacing material.



Floors and panel activities are available in two types of material: Waterproof plywood decks thickness 21.5mm from pine and alder wood with anti-slip film on both sides. High Pressure Laminate HPL thickness 17.8mm with slip resistant surface texture according to EN 438-6.

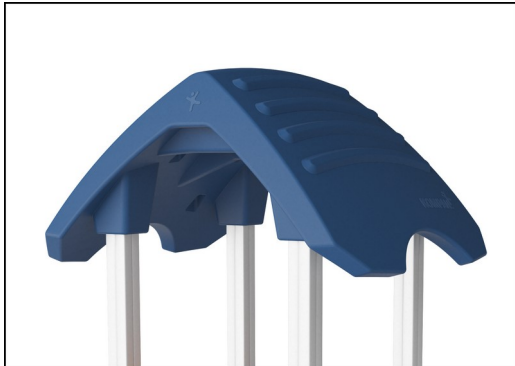

The large hollow components are made of 100% recyclable PE. The roof displayed is moulded in one piece with minimum 5,5mm wall thickness to ensure high durability in all climates around the world.

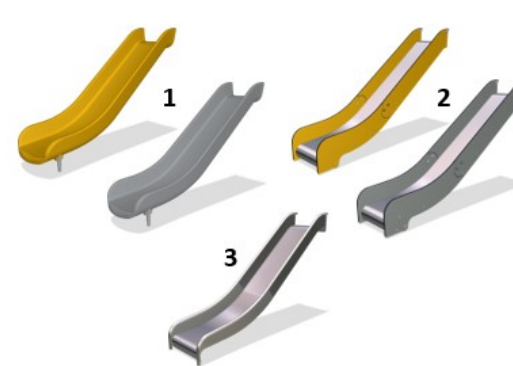

Slides are available in three different materials: moulded on piece PE slides made from 33% post-consumer materials, Combined EcoCore™ sides and stainless steel slide bed t=2mm. Full stainless steel AISI304 t=2mm.

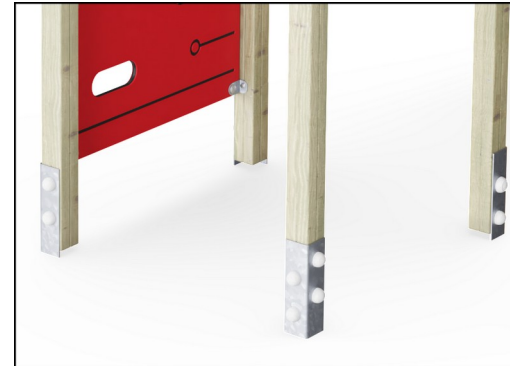

The main posts are equipped with hot dip galvanised steel footings. The steel footings elevates the posts 20mm from ground level to avoid contact with surfacing material.

Item no. KPL300911-0601

Installation Information

Max. fall height	100 cm
Safety surfacing area	26.0 m ²
Total installation time	16.6
Excavation volume	0.97 m ³
Concrete volume	0.00 m ³
Footing depth (standard)	60 cm
Shipment weight	389 kg
Anchoring options	In-ground ✓ Surface ✓

Warranty Information

Aluminum	15 years
EcoCore HDPE	Lifetime
Hollow PE parts	10 years
Pinewood	10 years
Spare parts guaranteed	10 years



Sustainability Data

KPL3009



Cradle to Gate A1-A3	Total CO ₂ emission	CO ₂ e/kg	Recycled materials
	kg CO ₂ e	kg CO ₂ e/kg	%
KPL300911-0601	397.85	1.34	36.62

The overall framework applied for these factors is the Environmental Product Declaration (EPD), which quantifies "environmental information on the life cycle of a product and enable comparisons between products fulfilling the same function" (ISO, 2006). This follows the structure and applies a Life-Cycle Assessment approach to the entire Product stage from raw material through manufacturing (A1-A3))

Kompan A/S
 C.F. Tietgens Boulevard 32C
 DK-5220 Odense SØ
 Denmark



Verification of CO₂ calculation of: Play systems



Data version no. 2023-10-05

The CO₂ calculation and data are in compliance with the principles of a carbon footprint impact according to the GHG protocol (Greenhouse Gas Protocol), Scope 3, cradle to gate related to all individual components in the product category: "Play systems" represented by item no.: PCM200321-0950.

(Scope 3 emissions include emission sources in the upstream and downstream value chain).

Date: 30. October 2023 | Valid until: 30. October 2025

Verified by:

Julie Marie Vejsgaard Larsen, LCA & EPD Consultant

Verification based on report: Validation of CO₂ calculation of 9 categories of Kompan product line, version 1.0, prepared by: Bureau Veritas HSE, Denmark: Julie M. V. Larsen.

Publication date: 30. October 2023

By Bureau Veritas HSE
 www.bureauveritas.dk
 +45 7731 1000



Triple Tower with Bridges

KPL3009

* Max fall height | ** Total height | *** Safety surfacing area

* Max fall height | ** Total height

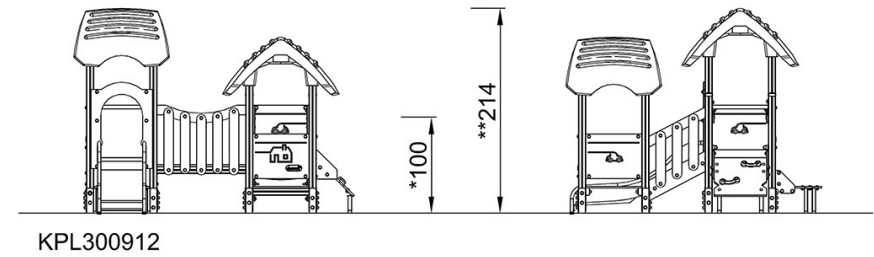
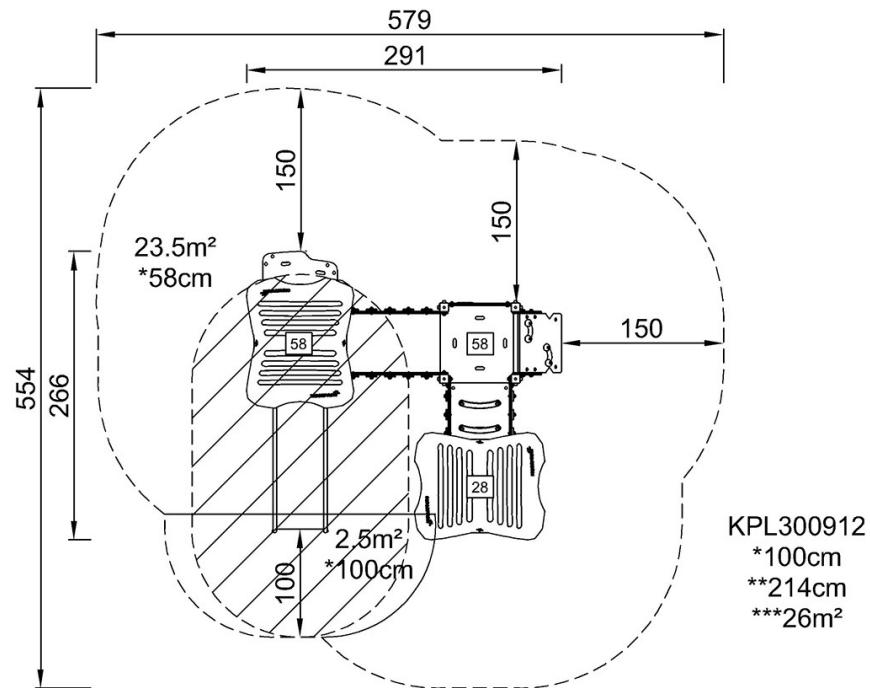

[Click to see TOP VIEW](#)

[Click to see SIDE VIEW](#)